

SOT-89 Plastic-Encapsulate Transistors

FEATURES

- Compliment to PXT8550
- TRANSISTOR (PNP)

MECHANICAL DATA

- Case style: SOT-89 -3L molded plastic
- Mounting position: any

SOT-89-3L

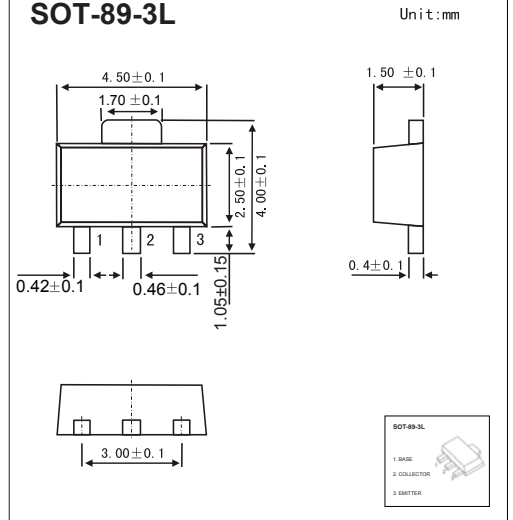

MAXIMUM RATINGS AND CHARACTERISTICS

@ 25°C Ambient Temperature (unless otherwise noted)

Symbol	Parameter	Value	Unit
V _{CB0}	Collector-Base Voltage	40	V
V _{CEO}	Collector-Emitter Voltage	25	V
V _{EBO}	Emitter-Base Voltage	5	V
I _C	Collector Current -Continuous	1.5	A
P _C	Collector Power dissipation	0.5	W
R _{θJA}	Thermal Resistance From Junction To Ambient	250	°C/W
T _J	Storage Temperature	150	°C
T _{stg}	Storage Temperature	-55~150	°C

PACKAGE INFORMATION

Device	Package	Shipping
PXT8050	SOT-89	1000/Tape&Reel

Parameter	Symbol	Test conditions	Min	Typ	Max	Unit
Collector-base breakdown voltage	V _{(BR)CBO}	I _C =100μA, I _E =0	40			V
Collector-emitter breakdown voltage	V _{(BR)CEO}	I _C =0.1mA, I _B =0	25			V
Emitter-base breakdown voltage	V _{(BR)EBO}	I _E =100μA, I _C =0	5			V
Collector cut-off current	I _{CB0}	V _{CB} =40V, I _E =0			0.1	μA
Emitter cut-off current	I _{CEO}	V _{CE} =20V, I _E =0			0.1	μA
Emitter cut-off current	I _{EBO}	V _{EB} =5V, I _C =0			0.1	μA
DC current gain	h _{FE(1)}	V _{CE} =1V, I _C =100mA	85		400	
	h _{FE(2)}	V _{CE} =1V, I _C =800mA	40			
Collector-emitter saturation voltage	V _{CE(sat)}	I _C =800mA, I _B =80mA			0.5	V
Base-emitter saturation voltage	V _{BE(sat)}	I _C =800mA, I _B =80mA			1.2	V
Base-emitter voltage	V _{BE}	V _{CE} =1V, I _C =10mA			1	V
Base-emitter positive forward voltage	V _{BEF}	I _B =1A			1.55	V
Transition frequency	f _T	V _{CE} =10V, I _C =50mA, f=30MHz	100			MHz
output capacitance	C _{ob}	V _{CB} =10V, I _E =0, f=1MHz			15	pF

CLASSIFICATION OF h_{FE(1)}

Rank	B	C	D	D3
Range	85-160	120-200	160-300	300-400

Marking

Marking	Y1
---------	----

■ Typical Characteristics

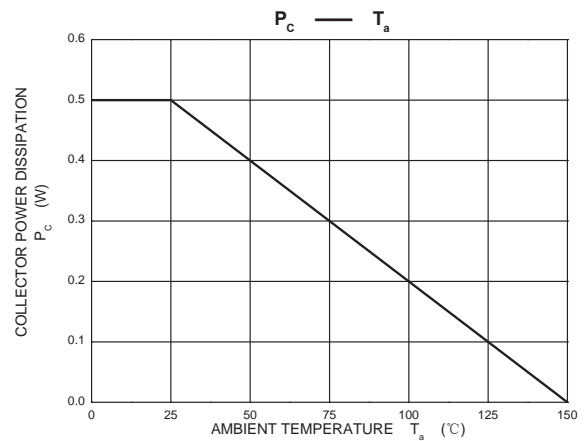
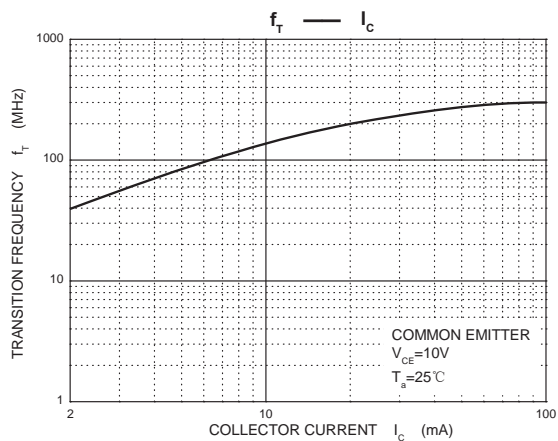
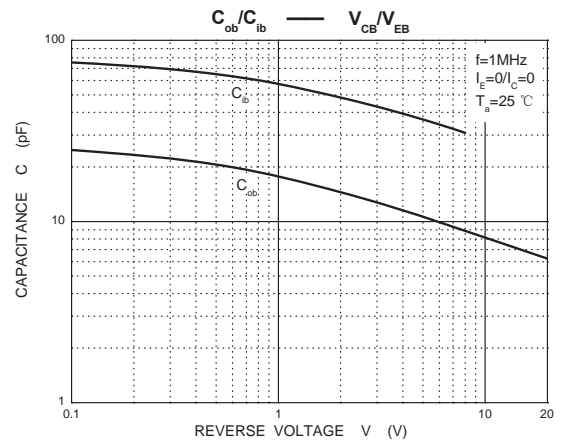
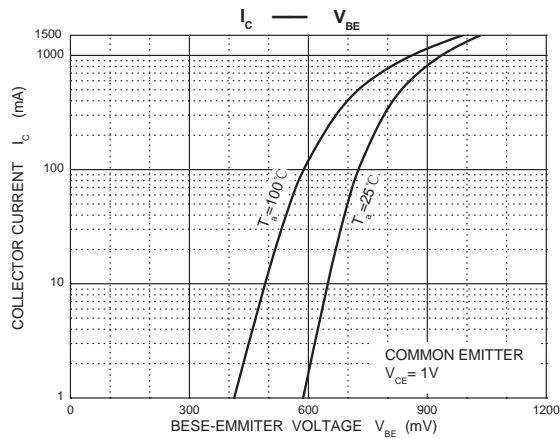
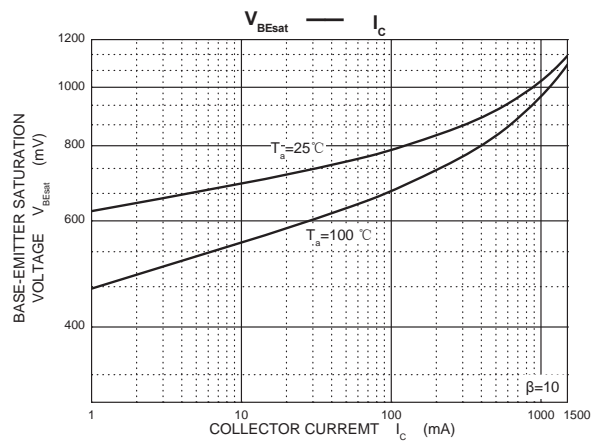
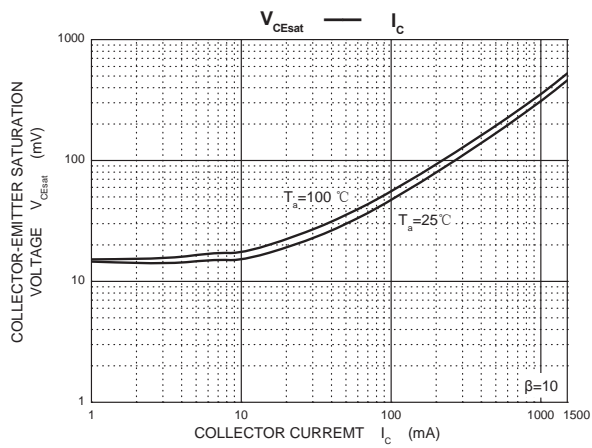
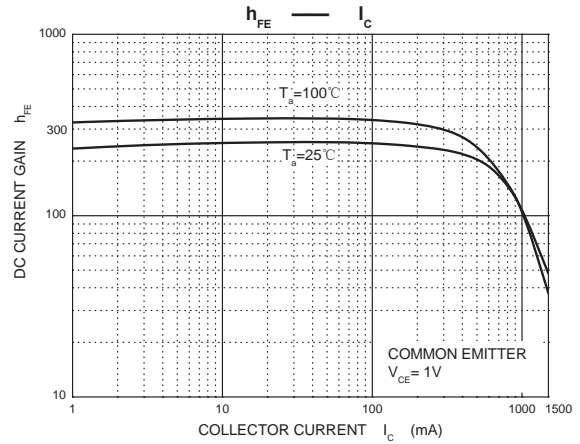
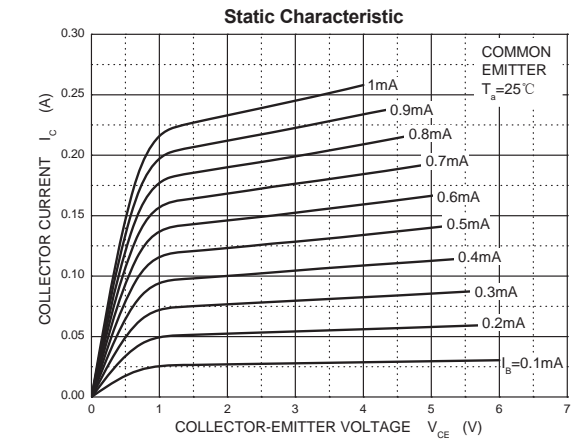

SOT-89-3L Tape and Reel

SOT-89-3L Embossed Carrier Tape

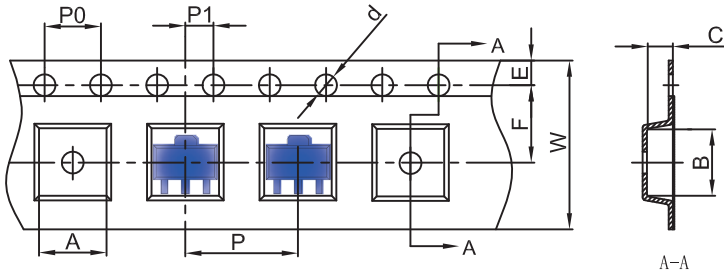

Packaging Description:

SOT-89-3L parts are shipped in tape. The carrier tape is made from a dissipative (carbon filled) polycarbonate resin. The cover tape is a multilayer film (Heat Activated Adhesive in nature) primarily composed of polyester film, adhesive layer, sealant, and anti-static sprayed agent. These reeled parts in standard option are shipped with 1,000 units per 7" or 18.0 cm diameter reel. The reels are clear in color and is made of polystyrene plastic (anti-static coated).

Dimensions are in millimeter										
Pkg type	A	B	C	d	E	F	P0	P	P1	W
SOT-89-3L	4.85	4.45	1.85	Ø1.50	1.75	5.50	4.00	8.00	2.00	12.00

SOT-89-3L Tape Leader and Trailer

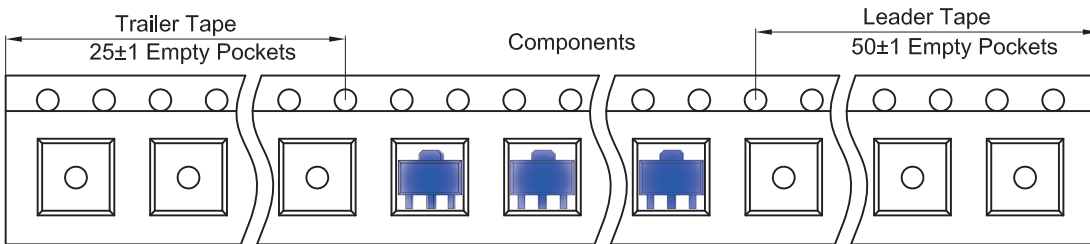

SOT-89-3L Reel

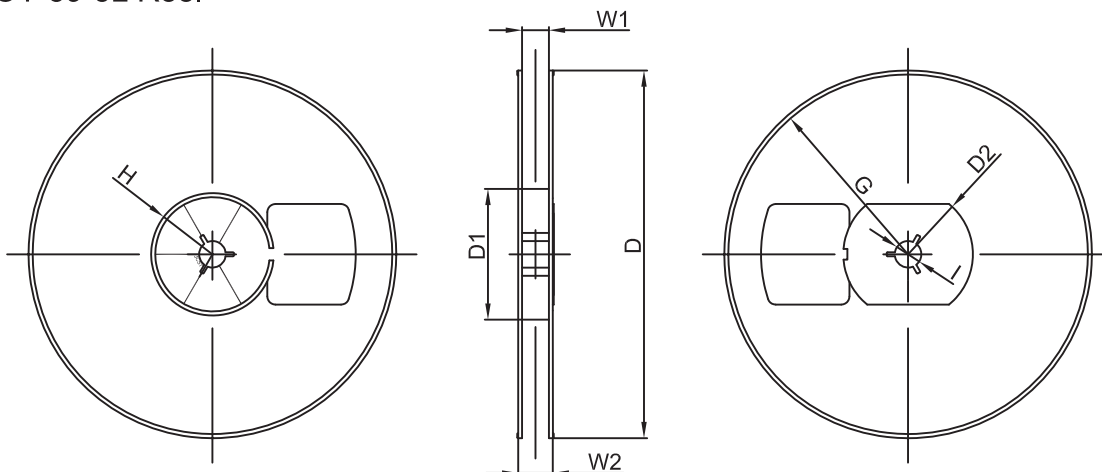

Dimensions are in millimeter								
Reel Option	D	D1	D2	G	H	I	W1	W2
7" Dia	Ø180.00	60.00	R32.00	R86.50	R30.00	Ø13.00	13.20	16.50

REEL	Reel Size	Box	Box Size(mm)	Carton	Carton Size(mm)	G.W.(kg)
1000 pcs	7 inch	10,000 pcs	203×203×195	40,000 pcs	438×438×220	